

RGB Image Compression by Low Complexity Multi-Level Block Truncation Code Algorithm

Dev Prakash Singh¹, Dr. Vineeta Saxena Nigam²

M. Tech. Scholar, Department of Electronics and Communication, UIT, RGPV, Bhopal, India¹

Professor, Department of Electronics and Communication, UIT, RGPV, Bhopal, India²

ABSTRACT: This paper aims to proposed multi-level block truncation code (BTC) based image compression of continuous tone still image to achieve low bit rate and high quality. The algorithm has been proposed by combining bit map and quantization. The algorithms are proposed based on the assumption that the computing power is not the limiting factor. The parameters considered for evaluating the performance of the proposed methods are compression ratio and subjective quality of the reconstructed images. The performance of proposed algorithm including color image compression, progressive image transmission is quite good. The effectiveness of the proposed schemes is established by comparing the performance with that of the existing methods.

KEYWORDS: Block Truncation Code (BTC), Bit Map, Multi-level, Quantization

I. INTRODUCTION

With the advent of the multimedia era and the growth of digital packet networks the total amount of image data accessed and exchanged by users has reached a huge value of several terabytes. Therefore, the need for compression of continuous tone still images has grown tremendously enormous. Image compression maps an original image in to a bit stream suitable for transmission and storage. The number of bits required to represent the compressed image should be smaller than that required for the original image. Compression is specified in terms of number of bits per pixel (bpp) or Compression Ratio (CR) [1]. The subjective quality of compressed image is specified by Peak Signal to Noise Ratio (PSNR). Digital image compression methods can be divided into two broad categories: 'lossless' and 'lossy' compression methods. Lossy compression methods are necessary to achieve high compression ratio. In a lossy compression system, the reconstructed image is not identical to the source image and very high compression ratio is possible at the expense of loss of visual quality [2]. Lossy compression algorithms are based on the principle of removal of subjective redundancy and are extremely important in applications such as transmission of still images over the internet where certain amount of distortion may be tolerated. Traditional image compression techniques such as run length coding, arithmetic coding and Huffman code are lossless coding schemes. Statistical redundancy present in the image can be effectively compressed using such lossless compression but the compression gain achieved is low [3-4]. The best compression ratio that can be achieved with current lossless compression standards such as Joint Photographic Experts Group (JPEG) is around 3 to 4. Transform coding is a widely applied method for lossy image compression. Image transforms effectively decorrelate the pixels so that pixels representing similar events in the image are grouped together according to their spatial or spectral properties. After transformation, the useful information is concentrated into a few of the low-frequency coefficients and the Human Visual System is more sensitive to such low spatial frequency information than to high spatial frequency [5]. This is achieved through certain orthogonal transforms such as like Karhunen- Loeve Transform (KLT), Discrete Cosine Transform (DCT), Discrete Sine Transform (DST), Walsh Hadamard Transform etc. Thus coding of transform coefficients can lead to substantial data reduction and it is currently one of the best coding techniques known. A primary example of the transform coding is the DCT-based JPEG image compression standard prepared by the ISO/IEC/JTC1/ SC2/WG10 committee popularly called the Joint Photographic Experts Group. It performs the lossy compression of the still images. However, it suffers from the drawback of blocking artifacts. Recently, the application of Discrete Wavelet Transform (DWT) in image compression has received significant attention and many wavelet based image compression algorithms have been proposed. The wavelet

International Journal of Innovative Research in Science, Engineering and Technology

(A High Impact Factor, Monthly, Peer Reviewed Journal)

Visit: www.ijirset.com

Vol. 6, Issue 12, December 2017

transform decomposes a signal into its various frequency components. In the case of natural images, one obtains many small or zero-valued coefficients corresponding to the high-frequency components of the image. Due to the large number of small coefficients, the transformed signal is often easier to code than the original signal itself [6]. JPEG 2000 standard is based on transform coding employing DWT. It achieves high compression ratio and improved subjective quality especially at low bit rates than the previous DCT-based JPEG [7].

II. ELEMENTS OF LOSSY IMAGE COMPRESSION SYSTEM

In transform based image compression, the image is subjected to transformation and then the transformed data are encoded to produce the compressed bit stream. The general structure of a transform-based image compression system is shown in Figure 1. There are two versions of transform coding. One is frame based and the other is the block based. The block based approach requires fewer computations and allows adaptive quantization of coefficients.

In Figure 1, X represents the original image pixel values; Y_i denotes the transformed values of the original image. All the transformed coefficients are then quantized and entropy coded which are represented by C_i . These compressed bit streams are either transmitted or stored. Reconstructed image can be obtained by decompressing the coded signal. The goal is to design a system so that the coded signal C_i can be represented with fewer bits than the original image X [8].

In the 1980's, almost all transform based compression approaches were using the DCT. Later, the trend moved to compression schemes based on the DWT. DWT overcomes the effect of blocking artifacts associated with DCT. Perhaps the most significant improvement in conventional coding is achieved by the use of arithmetic coders instead of simple Huffman coders, which increases the compression ratio by 5-8%. However, the multimedia content in daily life is growing exponentially; therefore, a performance gain of about 10% in ten years does not satisfy the demand. Therefore, researchers have been looking for new solutions that could solve the problem of the stagnating image compression performance.

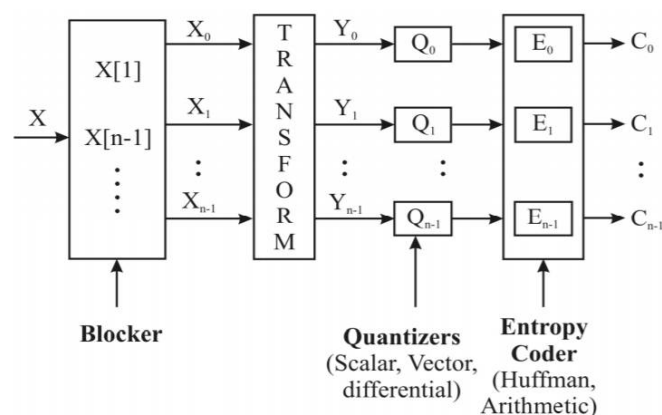

Figure 1: Transform-based image compression system

Finally, the quantized coefficients are coded to produce the compressed bit stream. The coding process typically exploits a statistical model in order to code symbols with fewer bits for symbols that has higher probability of occurrence. In doing so, the size of the compressed bit stream is reduced. Assuming that the transform employed is truly invertible, the only potential cause for information loss is in the coefficient quantization, as the quantized coefficients are coded in a lossless manner [9]. The decompression process simply mirrors the process used for compression. The compressed bit stream is decoded to obtain the quantized transform coefficients. Then, the inverse of the transform used during compression is employed to obtain the reconstructed image.

International Journal of Innovative Research in Science, Engineering and Technology

(A High Impact Factor, Monthly, Peer Reviewed Journal)

Visit: www.ijirset.com

Vol. 6, Issue 12, December 2017

III. IMAGE QUALITY MEASURES

It is a major task in evaluating the image quality of an image compression system to describe the amount of degradation in the reconstructed image. In the case of lossy compression, the reconstructed image is only an approximation to the original. The difference between the original and reconstructed signal is referred to as approximation error or distortion. Generally, the performance is evaluated in terms of compression ratio and image fidelity [10]. A good image compression algorithm results in a high compression ratio and high fidelity. Unfortunately, both requirements cannot be achieved simultaneously. Although many metrics exist for quantifying distortion, it is most commonly expressed in terms of means squared error (MSE) or peak-signal-to-noise ratio (PSNR). The performance of image compression systems is measured by the metric defined in equations (1) and (2). It is based on the assumption that the digital image is represented as $N_1 \times N_2$ matrix, where N_1 and N_2 denote the number of rows and columns of the image respectively. Also, $f(i, j)$ and $g(i, j)$ denote pixel values of the original image before compression and degraded image after compression respectively.

Mean Square Error (MSE)

$$= \frac{1}{N_1 N_2} \sum_{j=1}^{N_2} \sum_{i=1}^{N_1} (f(i, j) - g(i, j))^2 \quad (1)$$

Peak Signal to Noise Ratio (PSNR) in dB

$$= 10 \times \log_{10} \left(\frac{255^2}{MSE} \right) \quad (2)$$

Evidently, smaller MSE and larger PSNR values correspond to lower levels of distortion. Although these metrics are frequently employed, it can be observed that the MSE and PSNR metrics do not always correlate well with image quality as perceived by the human visual system. For this reason, it is preferable to supplement any objective lossy compression performance measurement by subjective tests such as the Mean Opinion Score (MOS) to ensure that the objective results are not misleading [11].

Sometimes compression is quantified by stating the Bit Rate (BR) achieved by compression algorithm expressed in bpp (bits per pixel). Another parameter that measures the amount of compression is the Compression Ratio (CR) which is defined as

$$CR = \frac{\text{Original image size}}{\text{Compressed image size}} \quad (3)$$

IV. PROPOSED METHODOLOGY

Proposed Encoder and decoder block of the multi-level block truncation code algorithm is shown in figure 2. Encoder part of the proposed algorithm shows that the original image is divided into three parts i.e. R component, G component and B component. Each R, G, B component of the image is divided into non overlapping block of equal size and threshold value for each block size is being calculated.

International Journal of Innovative Research in Science, Engineering and Technology

(A High Impact Factor, Monthly, Peer Reviewed Journal)

Visit: www.ijirset.com

Vol. 6, Issue 12, December 2017

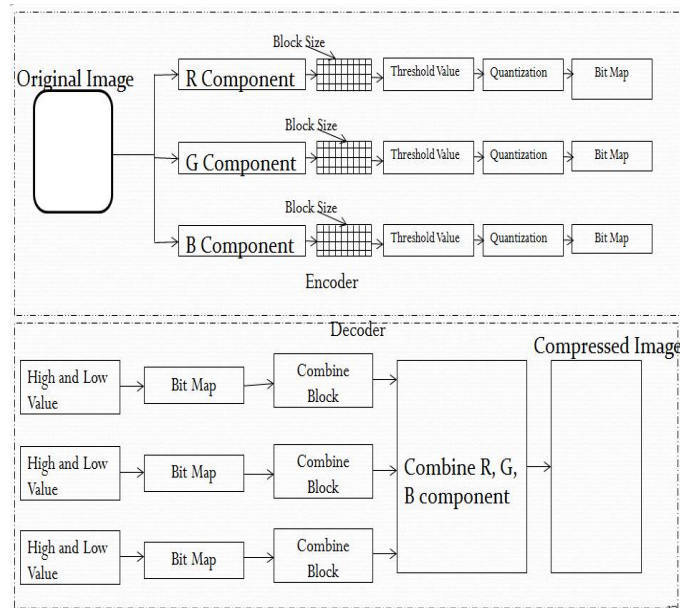

Figure 2: Block Diagram of Proposed Algorithm

Threshold value means the average of the maximum value (max) of 'k × k' pixels block, minimum value (min) of 'k × k' pixels block and m_1 is the mean value of 'k × k' pixels block. Where k represents block size of the color image. So threshold value is:

$$T = \frac{\max + \min + m_1}{3} \quad (4)$$

Each threshold value is passing through the quantization block. Quantization is the process of mapping a set of input fractional values to a whole number. Suppose the fractional value is less than 0.5, then the quantization is replaced by previous whole number and if the fractional value is greater than 0.5, then the quantization is replaced by next whole number. Each quantization value is passing through the bit map block. Bit map means each block is represented by '0' and '1' bit map. If the Threshold value is less than or equal to the input image value then the pixel value of the image is represented by '0' and if the threshold value is greater than the input image value then the pixel value of the image is represented by '1'.

Bit map is directly connected to the high and low component of the proposed decoder multi-level BTC algorithm. High (H) and low (L) component is directly connected to the bit map, bitmap converted the '1' and '0' pixel value to high and low pixel value and arrange the entire block.

$$L = \frac{1}{p} \sum_{i=1}^p W_i \quad W_i \leq T \quad (5)$$

$$H = \frac{1}{q} \sum_{j=1}^q W_j \quad W_j > T \quad (6)$$

W_i represent the input color image block, q is the number of zeros in the bit plane, p is the number of ones in the bit plane. In the combine block of decoder, the values obtained from the pattern fitting block of individual R, G,B components are combined after that all the individual combined block are merged into a single block. Finally compressed image and all the parameter relative to that image will be obtained.

V. SIMULATION RESULT

Figure 3; shows the Satellite image of 2×2 block pixel. In this figure 3 (a) show the random image of the Satellite image and resize the image of the 512×512 in the Satellite image shown in figure 3 (b). The compressed image is 2×2 block pixel of Satellite image shown in figure 3 (c) respectively.

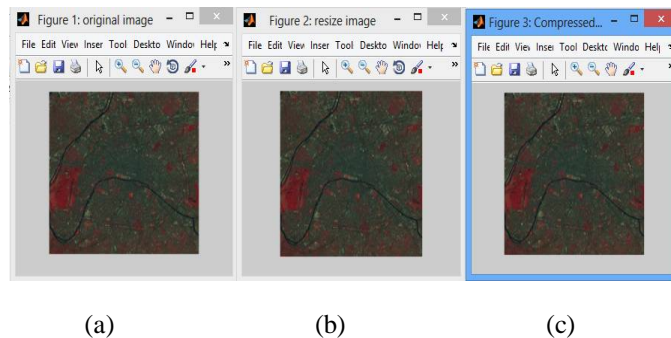

Figure 3: Multi-level BTC Algorithm applied on Satellite Image of block size 2×2

Figure 4; shows the Satellite image of 4×4 block pixel. In this figure 4 (a) show the random image of the Satellite image and resize the image of the 512×512 in the Satellite image shown in figure 4 (b). The compressed image is 4×4 block pixel of Satellite image shown in figure 4 (c) respectively.

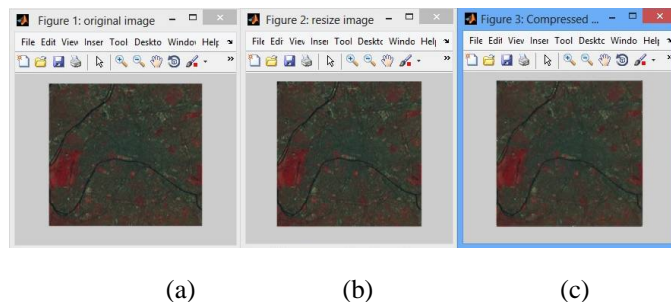

Figure 4: Multi-level BTC Algorithm applied on Satellite Image of block size 4×4

As shown in table 1 the peak signal to noise ratio (PSNR) and computation time are obtained from the proposed multi-level block truncation code algorithm. The values obtained for various block sizes is the average value of red, blue and green component of the image.

International Journal of Innovative Research in Science, Engineering and Technology

(A High Impact Factor, Monthly, Peer Reviewed Journal)

Visit: www.ijirset.com

Vol. 6, Issue 12, December 2017

Table 1: Experimental Results MSE, PSNR, CT and CR for Satellite Image

Image	Proposed Multi-level BTC Algorithm				C Senthil Kumar et al. [1]		
	MSE	PSNR (dB)	CR (%)	CT (ns)	MSE	PSNR (dB)	CT (ns)
Block Size (2×2)	166.34	59.535	7.4	2.089	349.08	34.17	3.76
Block Size (4×4)	168.43	46.761	32.89	2.621	387.87	38.45	3.76
Block Size (8×8)	172.45	44.793	56.14	2.884	334.19	35.97	3.74
Block Size (32×32)	184.43	41.984	77.41	3.297	373.63	36.53	3.71
Block Size (128×128)	193.43	41.680	83.75	3.432	364.33	37.20	3.81
Block Size (512×512)	204.54	41.4722	86.07	3.6320	390.17	39.41	3.74

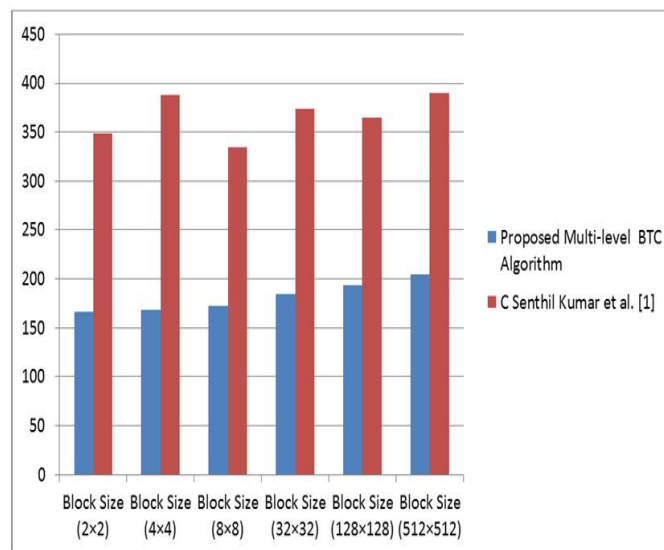

Figure 5: MSE for Different Block Size using Satellite Image

Figure 5 shows the graphical illustration of the performance of different block size discussed in this research work in term of MSE. From the above graphical representation it can be inferred that the proposed multi-level block truncation code algorithm gives the best performance for 2×2 Block Pixel.

International Journal of Innovative Research in Science, Engineering and Technology

(A High Impact Factor, Monthly, Peer Reviewed Journal)

Visit: www.ijirset.com

Vol. 6, Issue 12, December 2017

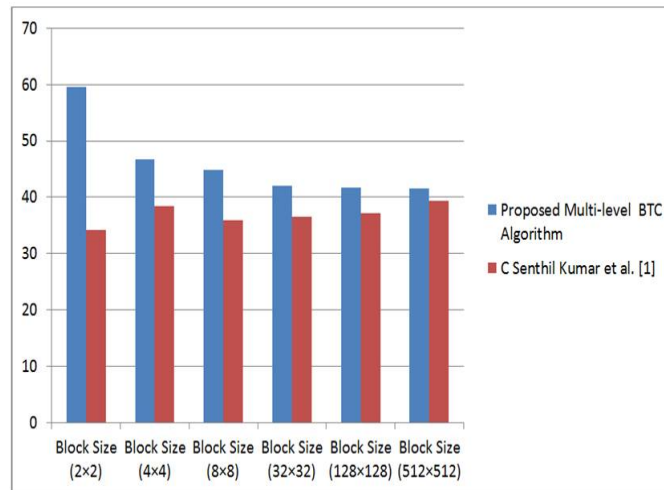

Figure 6: MSE for Different Block Size using Satellite Image

Figure 6 shows the graphical illustration of the performance of different block size discussed in this research work in term of PSNR. From the above graphical representation it can be inferred that the proposed multi-level block truncation code algorithm gives the best performance for 2x2 Block Pixel.

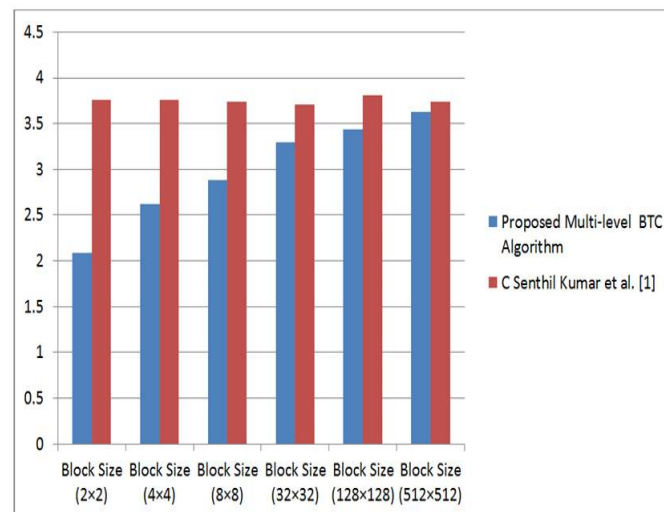

Figure 7: Computation Time for Different Block Size using Satellite Image

Figure 7 shows the graphical illustration of the performance of different block size discussed in this research work in term of computation time. From the above graphical representation it can be inferred that the proposed block truncation code pattern fitting (BTC-PF) algorithm gives the best computation time for 2x2 Block Pixel.

International Journal of Innovative Research in Science, Engineering and Technology

(A High Impact Factor, Monthly, Peer Reviewed Journal)

Visit: www.ijirset.com

Vol. 6, Issue 12, December 2017

VI. CONCLUSION

In the proposed method compression ratio for block size (2×2) is 7.4%, block size (4×4) is 32.89%, block size (8×8) is 56.14%, block size (16×16) is 69.95%, block size (32×32) is 77.41%, block size (128×128) is 83.75% and block size (512×512) is 86.07% for satellite image. It is clear that by increasing block size, compression ratio also increases and image quality degrades for satellite image.

REFERENCES

- [1] C. Senthil kumar, "Color and Multispectral Image Compression using Enhanced Block Truncation Coding [E-BTC] Scheme", *accepted to be presented at the IEEE WiSPNET*, PP. 01-06, 2016 IEEE.
- [2] Jing-Ming Guo, *Senior Member, IEEE*, and Yun-Fu Liu, *Member, IEEE*, "Improved Block Truncation Coding Using Optimized Dot Diffusion", *IEEE TRANSACTIONS ON IMAGE PROCESSING*, VOL. 23, NO. 3, MARCH 2014.
- [3] Jayamol Mathews, Madhu S. Nair, "Modified BTC Algorithm for Gray Scale Images using max-min Quantizer", 978-1-4673-5090-7/13/\$31.00 ©2013 IEEE.
- [4] Ki-Won Oh and Kang-Sun Choi, "Parallel Implementation of Hybrid Vector Quantizerbased Block Truncation Coding for Mobile Display Stream Compression", *IEEE ISCE 2014* 1569954165.
- [5] Seddeq E. Ghrare and Ahmed R. Khobaiz, "Digital Image Compression using Block Truncation Coding and Walsh Hadamard Transform Hybrid Technique", *2014 IEEE 2014 International Conference on Computer, Communication, and Control Technology (I4CT 2014)*, September 2 - 4, 2014 - Langkawi, Kedah, Malaysia.
- [6] M. Brunig and W. Niehsen. Fast full search block matching. *IEEE Transactions on Circuits and Systems for Video Technology*, 11:241 – 247, 2001.
- [7] K. W. Chan and K. L. Chan. Optimisation of multi-level block truncation coding. *Signal Processing: Image Communication*, 16:445 – 459, 2001.
- [8] C. C. Chang and T. S. Chen. New tree-structured vector quantization with closed-coupled multipath searching method. *Optical Engineering*, 36:1713 – 1720, 1997.
- [9] C. C. Chang, H. C. Hsia, and T. S. Chen. A progressive image transmission scheme based on block truncation coding. In *LNCS Vol 2105*, pages 383–397, 2001.
- [10] William H. Equitz, 1989: "A New Vector Quantization Clustering Algorithm" *IEEE Transactions on Acoustics, Speech and Signal Processing*, Vol. 37, No. 10, pp. 1568-1575.
- [11] Wu X. and Zhang K., 1991: "A Better Tree-Structured Vector Quantizer", in *IEEE Proceedings of Data Compression Conference, Snowbird, UT*, pp. 392-4
- [12] Yang S.B., 2005: "Smooth Side-match Weighted Vector Quantizer with Variable Block Size for Image Coding", *IEEE Proceedings – Visual Image Signal Processing*, Vol. 152, No. 6, pp. 763-770